



Pacific Northwest
NATIONAL LABORATORY

*Proudly Operated by **Battelle** Since 1965*

Advanced Networking Paradigms for High-DER Distribution Grids

Version 3.0

May 2016

JD Taft

DISCLAIMER

This report was prepared as an account of work sponsored by an agency of the United States Government. Neither the United States Government nor any agency thereof, nor Battelle Memorial Institute, nor any of their employees, makes **any warranty, express or implied, or assumes any legal liability or responsibility for the accuracy, completeness, or usefulness of any information, apparatus, product, or process disclosed, or represents that its use would not infringe privately owned rights.** Reference herein to any specific commercial product, process, or service by trade name, trademark, manufacturer, or otherwise does not necessarily constitute or imply its endorsement, recommendation, or favoring by the United States Government or any agency thereof, or Battelle Memorial Institute. The views and opinions of authors expressed herein do not necessarily state or reflect those of the United States Government or any agency thereof.

PACIFIC NORTHWEST NATIONAL LABORATORY
operated by
BATTELLE
for the
UNITED STATES DEPARTMENT OF ENERGY
under Contract DE-AC05-76RL01830

Printed in the United States of America

Available to DOE and DOE contractors from the
Office of Scientific and Technical Information,
P.O. Box 62, Oak Ridge, TN 37831-0062;
ph: (865) 576-8401
fax: (865) 576-5728
email: reports@adonis.osti.gov

Available to the public from the National Technical Information Service
5301 Shawnee Rd., Alexandria, VA 22312
ph: (800) 553-NTIS (6847)
email: orders@ntis.gov <<http://www.ntis.gov/about/form.aspx>>
Online ordering: <http://www.ntis.gov>



This document was printed on recycled paper.

(8/2010)

Advanced Networking Paradigms for High-DER Distribution Grids

Version 3.0

JD Taft
Chief Architect for Electric Grid Transformation
PNNL

May 2016

Prepared for
the U.S. Department of Energy
under Contract DE-AC05-76RL01830

Pacific Northwest National Laboratory
Richland, Washington 99352

Contents

1.0	Background and Scenario.....	1
1.1	Broad Access.....	1
1.2	DER Penetration.....	1
1.3	Range of Grid Dynamics and Shift to Faster Dynamics	2
1.4	Changing ICT Structure	2
1.5	DER Aggregators, Remote BEMS, and DSOs.....	3
2.0	New Network Paradigms.....	3
2.1	System Control Networks	4
2.2	Substation Aggregation	4
2.3	Distribution Fiber to Premises and Private LTE: Field Area and Neighborhood Networks	6
2.4	Pub/Sub Networks and Information in Motion	6
2.5	Sensor Network Infrastructure (SNI)	7
2.6	Laminar Networks.....	8
2.7	Distributed Computing for Infrastructure (DCI)	11
2.8	Networking Outside the Utility Fence.....	12
2.9	Control System/Network Interaction	15
3.0	Network Convergence Issues	16
4.0	Conclusions	17
	Appendix A – Graphical String Notation	A.1

Figures

1	Utility Time Scales	2
2	Example System Control Network Connectivity Model	4
3	Example Feeder to Substation Communication Aggregation.....	5
4	Intra-Substation Networks	6
5	Sensor Network Infrastructure Layer.....	7
6	Layered Decomposition Basis for Laminar Networks.....	9
7	Composable Laminar Network Elements	10
8	Distributed Computing for Infrastructure	11
9	Aggregations into DO and ISO.....	12
10	Basic Laminar Coordination Options	14
11	Third Party Connectivity to Coordination Nodes through the DO	15
12	Control System/Communication Network Convergence via SDN.....	16
13	Network Convergences.....	17
A.1	Utility Diagram with Laminar Coordination	A.1
A.2	Extraction of a Graphic String Model.....	A.2
A.3	Example with Internet and Utility Wireless Network.....	A.3

1.0 Background and Scenario

The changes affecting distribution grids had been well documented¹ and considerable work is underway to address these changes in the context of grid modernization. Much of the focus is on components – rooftop solar and controllable inverters, storage, electric vehicles, responsive loads, and building to grid services, or example. Less attention has been paid to the implications for design of distribution level communication networks, yet the need to change distribution communication network design paradigms is profound. This document is not intended to provide new network designs, but is intended to offer new network paradigms from which network architectures can be developed.

Typical distribution communication network architectures involve multiple unconverged networks (as many as eight), using hub-and-spoke (for SCADA) or wireless mesh (for AMI), with low payload bandwidths, high packet loss rates, and poor behavior during and immediately after power outages. The reason why multiple networks exist is partly due to the silo effect of various application systems, each of which is designed with its own network. This has led to a history of high installation, integration, and operational costs for distribution ICT systems.²

In order to identify and justify new communications network paradigms, we consider a likely scenario for distribution grids in high DER penetration environments. Key elements of such a scenario follow.

1.1 Broad Access

The shift toward localization of energy sources exemplified by rising popularity of multi-user microgrids, local energy resources and networks, and Community Choice Aggregation points to a necessary change in distribution grid operator business models, due to the decline in energy sales revenues, the threat of grid defection and their potential impacts on electric utilities. One of the responses to this trend is to convert the distribution utility from a one-way energy delivery channel to an open access network that supports much more diverse customer choice and upon which decentralized energy transactions can take place among many authorized participants. Where such interactions involve not just grid control but also market mechanisms, Transactive Energy³ system concepts introduce new communication network requirements.

1.2 DER Penetration

The addition of DER to the grid involves not only electrical connection, but also forecasting, control and coordination. Most DER are not directly connected to the utility communication and control network, but are controlled by third party aggregators and building managers, many of whom are not located in the distribution service area that contains the DER (and likely not even in the same state). Such third parties are mostly connected to the DER they manage via the internet. Given the desire to capitalize on locational value of DERs, communication paths must, of necessity be more complex than those of traditional distribution systems. Additional complication arises from the interest in being able to bid DER into both bulk system markets and distribution level markets, to both provide real time operational services and defer T or D infrastructure upgrades. With the growing diversity of types of DER being adopted and their

¹ JD Taft “Grid Architecture 2,” see appendix A, <http://gridarchitecture.pnnl.gov/media/white-papers/GridArchitecture2final.pdf>

² JD Taft and A Becker-Dippmann, “The Emerging Interdependence of the Electric Power Grid & Information and Communication Technology,” <http://www.osti.gov/scitech/biblio/1221500>

³ http://www.gridwiseac.org/about/transactive_energy.aspx

behavior patterns, additional communication paths will be needed to support accurate forecasting of DER grid impacts for both operational and planning purposes, if these potential locational values are to be realized.⁴

1.3 Range of Grid Dynamics and Shift to Faster Dynamics

In legacy distribution systems, except for protection, functions other than protection acted no faster than about five minutes, and much control was human-in-the-loop. As Variable Energy Resources (VER) such as rooftop solar and new technologies like power electronics penetrate the distribution grid, systems dynamics will shift toward faster operation, moving to sub-minute, and even sub-second response times. At the same time, many functions still will operate on a range of longer time scales as shown in Figure 1 below. The structural change of bifurcation of generation into bulk system and distribution-connected sources introduces these fast dynamics into the distribution system. This results in new control requirements and therefore new communication network requirements.

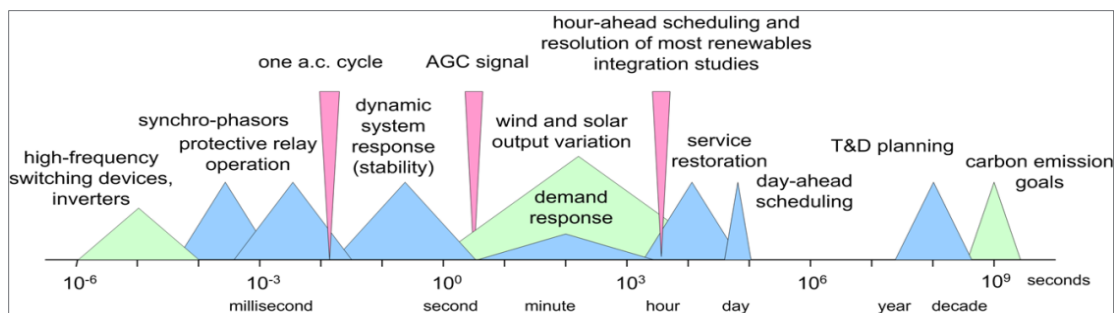

Figure 1. Utility Time Scales (Source: Alexandra von Meier)

1.4 Changing ICT Structure

Traditionally, computational capacity is owned and operated by the utility. Each utility has had an operations center and possibly a data center, and additionally may have had some amount of dedicated or embedded processing capability in various grid devices. More recently, technology progress has led to three developments that have the potential for drastically changing this mostly centralized computing structure:

1. Cloud – in the non-utility world many information systems capabilities are remotely hosted. This has not been viewed as a good option at electric utilities for the most part but that is changing as utility economics change. Smaller municipal utilities and co-ops may not have large internal IT support capability and so can see the value. For the larger IOUs, non-core IT applications are just starting to migrate to remote third party hosting or applications that have mobility from internal IT to external cloud, a concept termed “hybrid cloud.”
2. Smart Edge Devices – the same capabilities of computing and networking that have taken over cellphones are spreading to a variety of devices, including those connected at the edge of the grid. The presence of significant connected computing capability at these devices means they can be enabled to perform functions worthwhile to and interactive with the grid.

⁴ JD Taft, P De Martini, and L Kristov, “A Reference Model for Distribution Grid Control in the 21st Century,” http://gridarchitecture.pnnl.gov/media/advanced/Distribution%20Control%20Ref%20Model_v1.1_final.pdf

3. Internet – for the most part, the Cloud and smart edge devices make use of the internet for the connectivity that they require in order to function. For many such devices and applications this is the only connectivity option. While internet connectivity is convenient and easy in many (but not all) places, its use complicates the cyber security issue.

The combination of internet with either of the other two can have a profound impact on utility network architecture. Many of the distribution-connected energy resources that can in concert impact the operation of the grid have internet communication connectivity only. This poses a particular problem if the distribution utility wishes to coordinate DER in a manner that takes into account local feeder section conditions, such as congestion constraints.

1.5 DER Aggregators, Remote BEMs, and DSOs

The above-mentioned three technical capabilities have made possible the rise of third party operators/managers of responsive loads and DER. Consequently, for the utility that wishes to coordinate such grid-connected assets, it is necessary to work through these third parties, as they may have the only interfaces to the assets to be coordinated. Furthermore, the aggregator, merchant DER operator, or Building Energy Manager may have many assets in various parts of the country, and their operations centers may not be geographically located in the service area of the distribution utility to which the DER assets are electrically connected. In fact the third party may not even be in the same jurisdiction.

In addition, several states are working on redefining roles and responsibilities for distribution operators, and these emerging models, generally referred to as Distribution System Operator models, have more implications for utility communication connectivity on both the prosumer side, and the Transmission Operator/Balancing Area Authority side.⁵ Adding the dimension of wholesale market participation by DER and DER aggregations raises a need for three-way coordination between the distribution operator, the DER provider and the wholesale market and transmission system operator.

Because of the needs outline above, present networks are becoming inadequate, leading to the need for new methods and approaches. The rest of this paper will outline a number of paradigms that can inform such new approaches. While these are not designs, the paradigms can be the foundations for both architecture and designs for electric utility and smart city communication networks to support 21st Century grid modernization.

2.0 New Network Paradigms

Communication connectivity for modernized grids must move beyond hub-and-spoke models. Some electric utilities have already begun to make the change as legacy communications ages out, but many have not. This section introduces several new paradigms for electric utility communication networks that address the issues and trends described above. These new paradigms are: System Control Networks, Substation Aggregation, Distribution Fiber to Premises and Private LTE, Publish/Subscribe Networks, Sensor Network Infrastructure, Laminar Networks, and Distributed Computing for Infrastructure.

⁵ P De Martini and L Kristov, “Distribution Systems in High Distributed Energy Resources Future,” https://emp.lbl.gov/sites/all/files/FEUR_2%20distribution%20systems%2020151023_1.pdf

2.1 System Control Networks

Control of substation-based switchgear, regulators, and compensators is designated as system control. Operators are generally located in a centralized control or operations center, as are the systems that perform supervisory control, status display, crew dispatch, etc. Consequently, there is a need for communications between the control center and the substations.

At the transmission level, teleprotection can involve relays on each end of a transmission line cooperating with each other to protect the line. At the distribution level, there is no such need, but as distribution level system dynamics speed up, the need for controls at the substation level to cooperate on short time scales to maintain local balance. As intelligence is moved into the substations, there will be a need for peer-to-peer communications among the substations, as opposed to just substation-to-control center data flows (although those will still exist). Figure 2 below⁶ shows an example of a system control network configured for high bandwidth, low latency, scalability, and high reliability.

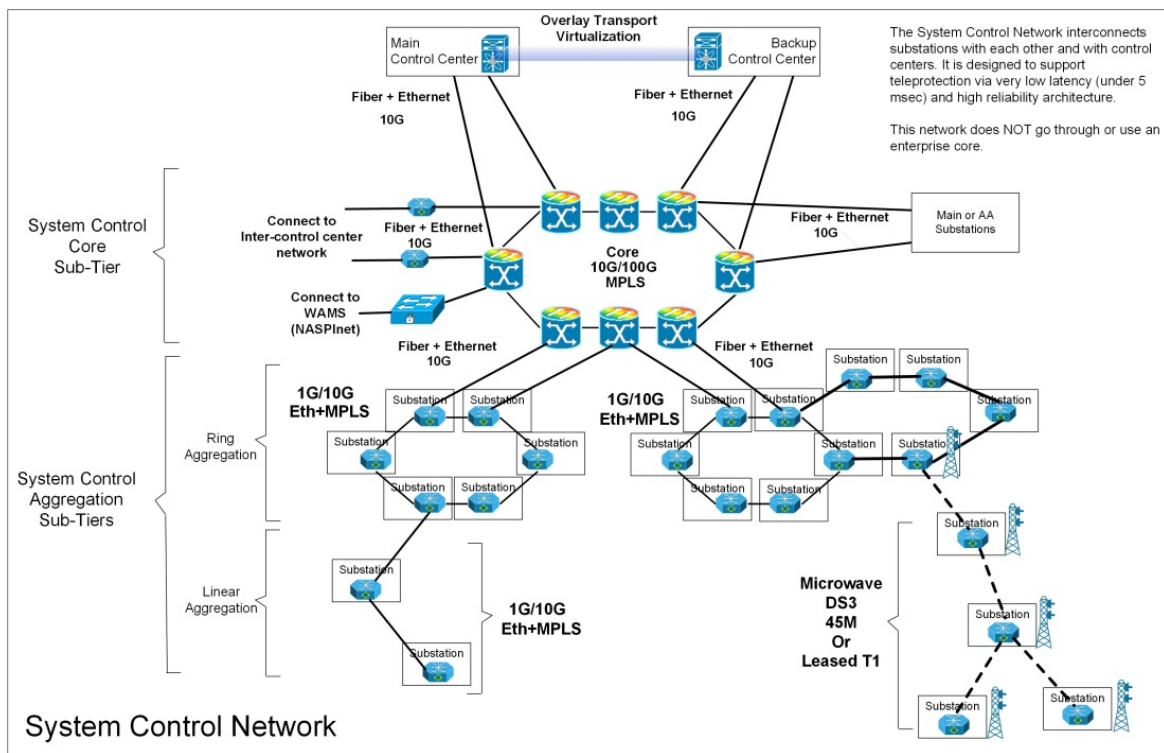

Figure 2. Example System Control Network Connectivity Model

2.2 Substation Aggregation

Standard design for distribution SCADA has been to use hub-and-spoke communication between feeder devices and the distribution control center. The physical network could also be hub-and-spoke, but may also be other forms with the logical data flow being hub-and-spoke. In any case, the communication is

⁶ Figures 2 and 3 adapted by permission from Cisco Systems. Figure 4 source: <https://developer.cisco.com/site/tad/overview/tech-overview.gsp>

between the grid devices and the control center. In some cases, distributed systems for FLISR⁷ use peer-to-peer communication.

As intelligence (analytics and control) for distribution move out to the distribution substations, it becomes necessary and useful to aggregate distribution feeder device data flows to the substations rather than the control center. This implies two network paradigms:

- Aggregation to the substations
- Internal networking in the substations that include connections for feeder aggregation, for connectivity inside the substation to local intelligence, and for connection to the system control network (see above)

An illustration of feeder level (field area) networking that aggregates to substations is shown in Figure 3 below.

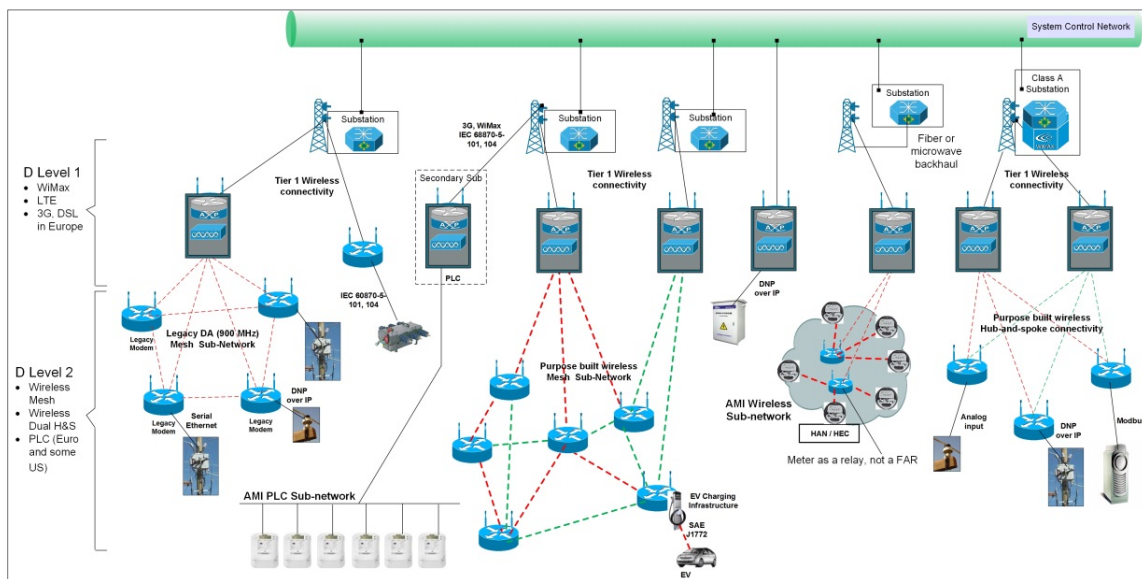

Figure 3. Example Feeder to Substation Communication Aggregation

Figure 4 below illustrates an intra-substation network model. In this model, the substation has three communication networks: the station bus that interconnects IEDs and related substation gear, the process bus the links IEDs with switchgear, and the multi-service bus that links other substation systems and provides the aggregation point for distribution feeder and neighborhood level device communications.

⁷ Fault Location, Isolation, and Service Restoration – see for example S&C IntelliTEAM II: <http://www.electricnet.com/doc/intelliteam-ii-automatic-restoration-system-0001>

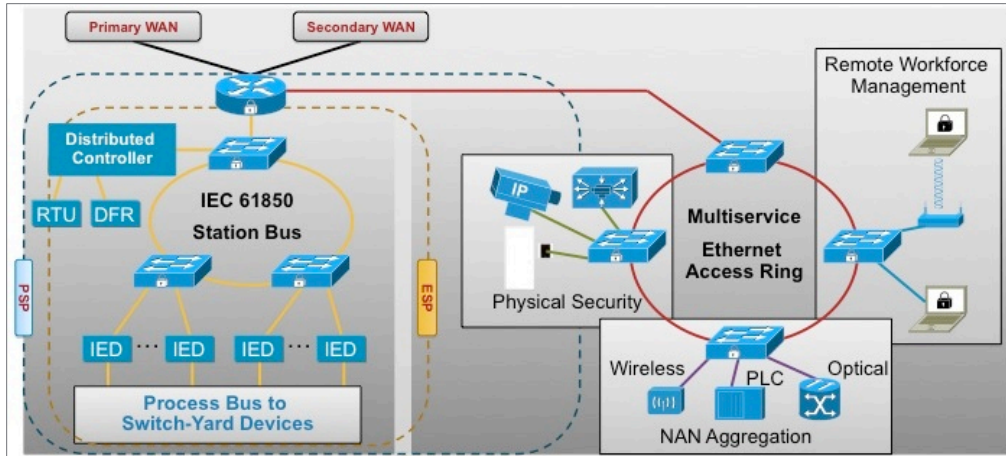

Figure 4. Intra-Substation Networks

The substation connects to a system control network, such as the type shown in Figure 2 via possibly redundant WAN interfaces.

2.3 Distribution Fiber to Premises and Private LTE: Field Area and Neighborhood Networks

Distribution utilities have traditionally viewed optical fiber as too expensive for distribution automation. The economics of fiber have been changing to the point where municipal utilities are finding fiber to be viable, especially in a smart city multi-infrastructure environment. Technologies for the deployment of fiber via natural gas lines⁸ or via above-ground and underground distribution circuits⁹ have emerged in response to the need for robust low-latency communication bandwidth in urban and suburban environments. Recently, the possibility of utilities building private LTE networks has arisen.¹⁰ Both forms of transport can be designed to aggregate to the appropriate substations, although for utilities with much existing fiber in place, the routing may be logical rather than strictly physical. For private LTE, it may be useful to locate towers in substations, which can facilitate substation aggregation. In either approach, data may need to move through the system control network between substations at times. This must be considered when planning the bandwidth requirements for the system control network.

2.4 Publish/Subscribe Networks and Information in Motion

Distribution grid communication has largely been via polling, asynchronous event messaging, and some report by exception. At the transmission level, the advent of Phasor Measurement Units (PMUs), which provide streaming data, has led to the use of well-established but advanced network protocols that allow the network to optimally manage streaming sensor data to multiple destinations, and to act as a publish-and-subscribe mechanism for authorized data recipients.¹¹ This leads to a paradigm that can be applied at

⁸ CPUC, Fiber in Gas, http://www.cpuc.ca.gov/Environment/info/esa/sempra-fig/fig/2_prijdesc.pdf

⁹ D O’Leary, ESB, “Fibre to the Building (FTTBN) Project,” EPRI International Technology Innovation Summit 2015.

¹⁰ <http://www.smartgridnews.com/story/true-game-changer-atts-private-lte-network-utilities/2016-02-11>

¹¹ Cisco Systems, “PMU Networking with IP Multicast,” http://www.cisco.com/c/en/us/products/collateral/routers/2000-series-connected-grid-routers/whitepaper_c11-697665.html

the distribution level as well: considering the communication network as more than data transport, but rather as the platform for information in motion.

The information-in-motion paradigm, mean that sensors can stream data and “publish” their data streams, and user applications can subscribe to sensor data streams as needed. This is generally referred to as a pub/sub model, and is used in enterprise IT systems design. The communication network can do the work of managing the data streams in this model, so no middleware layer is needed. The protocols involved are well established and conversion to the streaming mode can be accomplished at the first hop router, so no new protocols have to be implemented in the sensors. At the receiving end, protocol changes are minor if needed at all. This model is consonant with existing data acquisition paradigms, but the information-in-motion concept points to a better way to evaluate the value of the communication network itself. The streaming sensor-pub/sub-information-in-motion paradigm has implications for network design and also relates to the sensor network infrastructure paradigm below.

2.5 Sensor Network Infrastructure (SNI)

By re-structuring the normally vertically-siloed sensor/network/data collection head end/application stacks of various distribution grid systems such as AMI, SCADA, and DERMS,¹² and then by partitioning horizontally to group the sensors and communications network into a *single structure*, it is possible to separate the silos and decouple the applications from each other. This produces a *sensor network* for distribution grids that eliminates the need for back end exchange of sensor data among application systems and provides flexibility and scalability for both centralized and distributed systems. Figure 5 illustrates the revised structure.

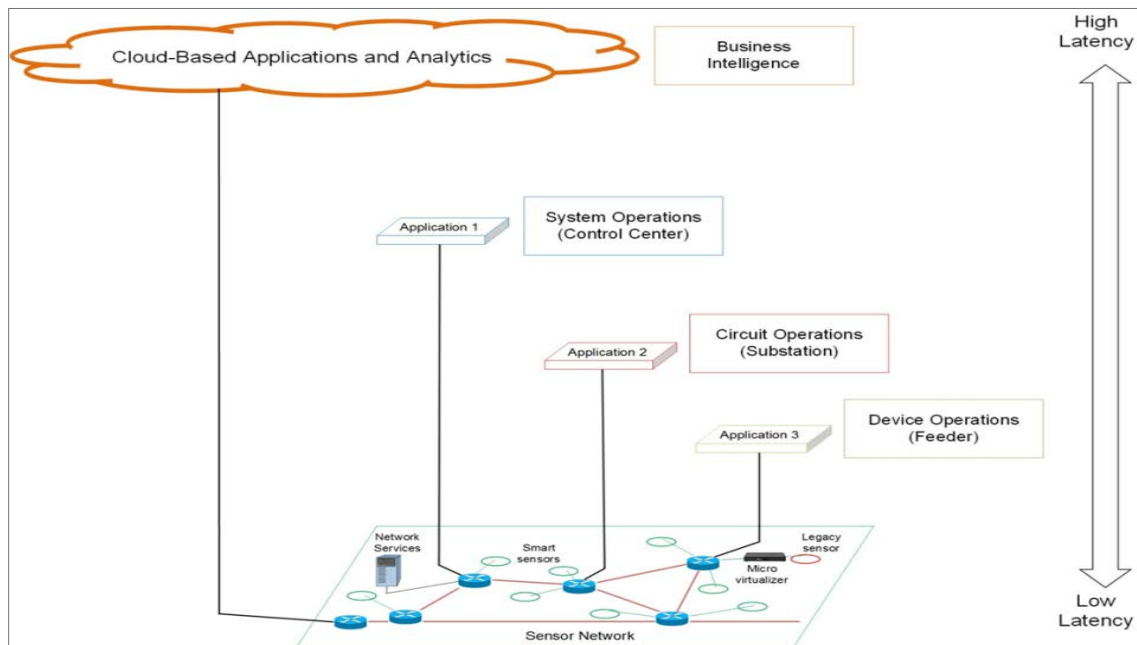

Figure 5. Sensor Network Infrastructure Layer

The sensor network architectural view treats sensors and the communication network as an integrated infrastructure layer. Various services are inserted into this structure and, where possible, the structure employs advanced communication protocols to provide capabilities often either built into siloed

¹² Distributed Energy Resources Management System

applications or supplied via an abstraction layer software platform (middleware). Data can flow from streaming sensors (sensors that produce continual streams of data, much like PMUs or video) to any authorized recipient application; in fact multiple devices or applications can receive such streams from the same sensor— applications merely need to be connected to the network at some point – in simple terms, “plug and play”. The sensor network can operate as a publish-and-subscribe data management system for information in motion, as mentioned above.¹³

For sensors that do not have streaming capability, local agents may perform the conversion or data acquisition engines may be attached to the edge of the sensor network to perform more traditional polling and other modes of data collection. Hence both legacy SCADA and more distributed data collection can coexist on the same network. Similarly, distributed database data store nodes may be attached to the sensor network, or data may be accumulated into individual applications. Each application may associate sensors as needed, providing low-latency grid data access with great flexibility.

Various services can be integrated into the sensor network via attached servers or through integration into network management systems. These include standard network management and security functions as well as grid-specific capabilities such as sensor meta-data management, IEC 61850 CIM interface services, and grid topology/connectivity.¹⁴ Services may be integrated into the sensor network layer via such techniques as service insertion, virtual routing and forwarding, and policy engines.

Given a network of smart sensors, it is possible to have applications associate to sensor subsets in a general and flexible manner. Applications can merely subscribe to the data from the appropriate set of sensors and sensor sets do not have to be disjoint, but can all be treated independently and grouped virtually by applications as needed. Applications may reside on sensor network-connected servers, in distributed computing elements, or even in the Cloud.

By converting siloed applications with dedicated communication networks into decoupled applications and a sensor/communication network infrastructure layer, the sensor network significantly changes both interoperability issues and the economics of utility network deployment.

2.6 Laminar Networks

The use of layered decomposition to derive a coordination framework leads to a communication structure that can be viewed as a combination of multi-layer hub-and-spoke and peer-to-peer forms arranged in a hierarchical self-similar structure. We designate such networks *Laminar Networks* since they are the underlying communication structures for Laminar Coordination Frameworks.¹⁵ Figure 6 below illustrates the Laminar Network concept. The upper left diagram shows the basic mathematical basis of layered decomposition.¹⁶ While the initial approaches to this used primal-dual decomposition, later work as employed more advanced methods such as partial dual decomposition and ADMM. Here we are not interested in the solution to any particular problem formulation; rather we are using this to discover structure and structural properties to inform network architecture. The lower left diagram illustrates

¹³ JD Taft and P De Martini, “Sensing and Measurement Architecture for Grid Modernization,” <http://gridarchitecture.pnnl.gov/media/advanced/Sensor%20Networks%20for%20Electric%20Power%20Systems.pdf>

¹⁴ As sensors proliferate, their position on the electric power network is essential. Depending on where the sensor is, that position may be dynamic with the action of automated feeder switches, reclosers and outage repair work.

¹⁵ JD Taft, “Grid Architecture 2”, pp. 3.11-3.19, <http://gridarchitecture.pnnl.gov/media/white-papers/GridArchitecture2final.pdf>

¹⁶ Mung Chiang, Steven Low, et al, “Layering as Optimization Decomposition: A Mathematical Theory of Network Architectures”, *Proceedings of the IEEE*, Vol. 95, No. 1, January 2007.

mapping of the decomposition onto grid structure. The upper right diagram shows the basic abstract network structures. The lower right diagram shows the resultant replicable unit structure resulting from the other three.

The basic module of Figure 6 (lower right) is used to define Coordination Domains, which is a recursive multi-scale concept. For example, at the substation level, a Coordination Domain is the entire substation service area. At the feeder level, it is the feeder service area. At the feeder section level, it is the circuit section and the devices connected to that section. These definitions follow from the layered decomposition process. Within any Coordination Domain, we further define a basic building block around the local level coordination node.

This is the essential replicable structure that can be used to compose Laminar Networks, which take on a form that combines layered hub-and-spoke flow with local intra-layer peer-to-peer flow and low bandwidth inter-layer data flow. These blocks can be composed both hierarchically and recursively as needed to build up Laminar Networks that follow the layered decomposition being employed. The Domain Coordinator is the local computing element that can provide local services and functions within a single instance of the coordination domain. In a Transactive Energy System, the domain coordinator can serve as a transactive node for its domain.

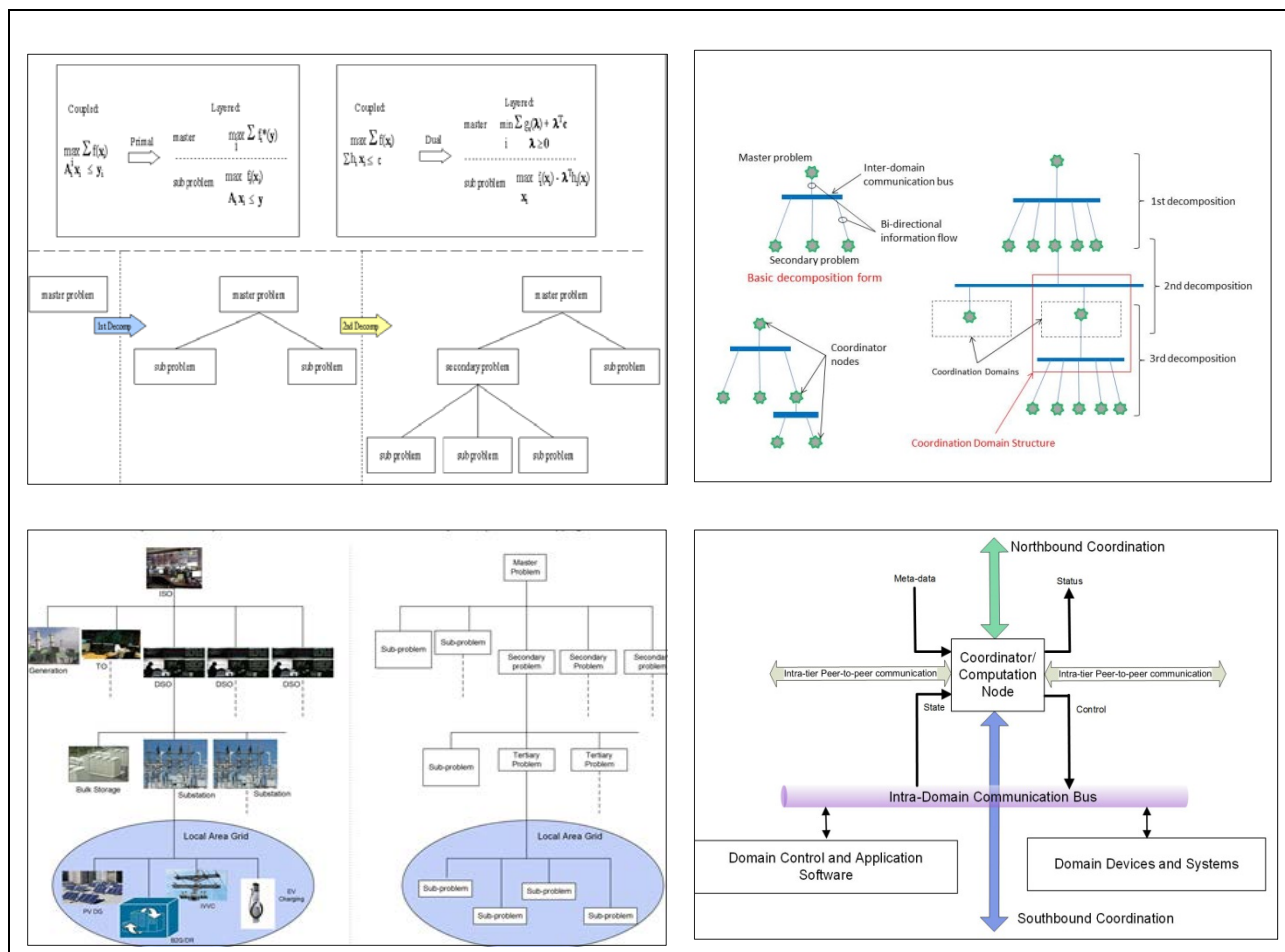

Figure 6. Layered Decomposition Basis for Laminar Networks

The Laminar Network can be the underlying structure for distribution level Transactive Energy Systems. In such an approach, the highest level coordination domain would be at the Distribution Operator control center and the lowest level coordination domain would be at the feeder section level. It is not necessary to go higher in the grid hierarchy if a DSO model is being used because from the DSO to the ISO/RTO, the essential transactive structure would already exist. The complete arrangement from ISO/RTO through Laminar Network to edge devices, integrated across the time dimension from planning to real-time control, constitutes *the Transactive Energy spectrum*.

When Laminar Networks are used in conjunction with layered decomposition-derived algorithms for coordination, control, or Transactive Energy, inter-layer communication is minimal since coordination signals do not aggregate¹⁷ across interlayer boundaries. As Figure 7 below illustrates, because Laminar Networks are composable, they easily accommodate the requirements for boundary deference and local selfish optimization capability needed in the layered decomposition approach. Such the networks are characterized by rich local data traffic (within coordination domains for example) but near constant flows along the vertical inter-tier chain, thus providing strong scalability. Laminar Networks have higher bandwidth requirements over short network radii (such as within a coordination domain) but lower bandwidth requirements over large network radii.

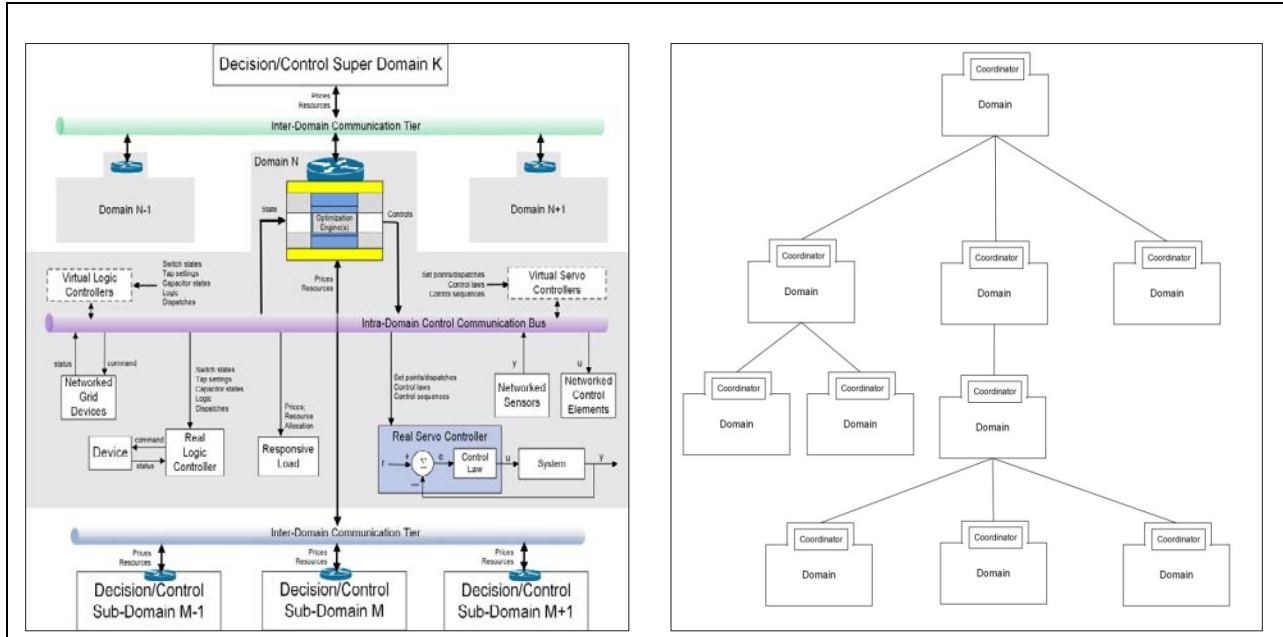

Figure 7. Composable Laminar Network Elements

The partitioning of the distribution control into coordination domains, with strong local (intra-domain peer-to-peer) communication, and limited inter-domain communication suggests that protocols such as XMPP can be applied inside the coordination domain to support peer-to-peer communication, with each coordination node acting as the necessary XMPP server for its coordination domain. XMPP is somewhat inefficient since the messages are text based, so for better efficiency, EXI can be used over XMPP

¹⁷ In communication networks, aggregation refers to the accumulation of data flows, resulting in larger consolidated flows. This is in contrast to the usage of the term aggregation in some other fields, where it means the summarization of data, resulting in decreases in data volumes.

networks to compress the message data via XEP-0322.¹⁸ Security key management for groups of devices inside a single coordination domain or across multiple domains can be managed via GDOI.¹⁹

2.7 Distributed Computing for Infrastructure (DCI)

If distribution grid control is to become more decentralized, then it is obvious that two things are needed: computing capacity in decentralized locations and communication networking to connect these computing elements. Any model for decentralized computing on the power grid must take into account the impact of DER and the fact that much DER will actually be controlled or coordinated through ESOs and aggregators. Figure 8 below shows one model for placement and connectivity of computing networks for grid infrastructure.²⁰ In addition to the traditional locations for computing equipment, it is reasonable to expect to see servers in substations, and embedded computing capacity at locations on the distribution feeder poles and in vaults (which already exists to some extent). In addition, connectivity must be provided to assets and organizations that exist outside the utility fence.

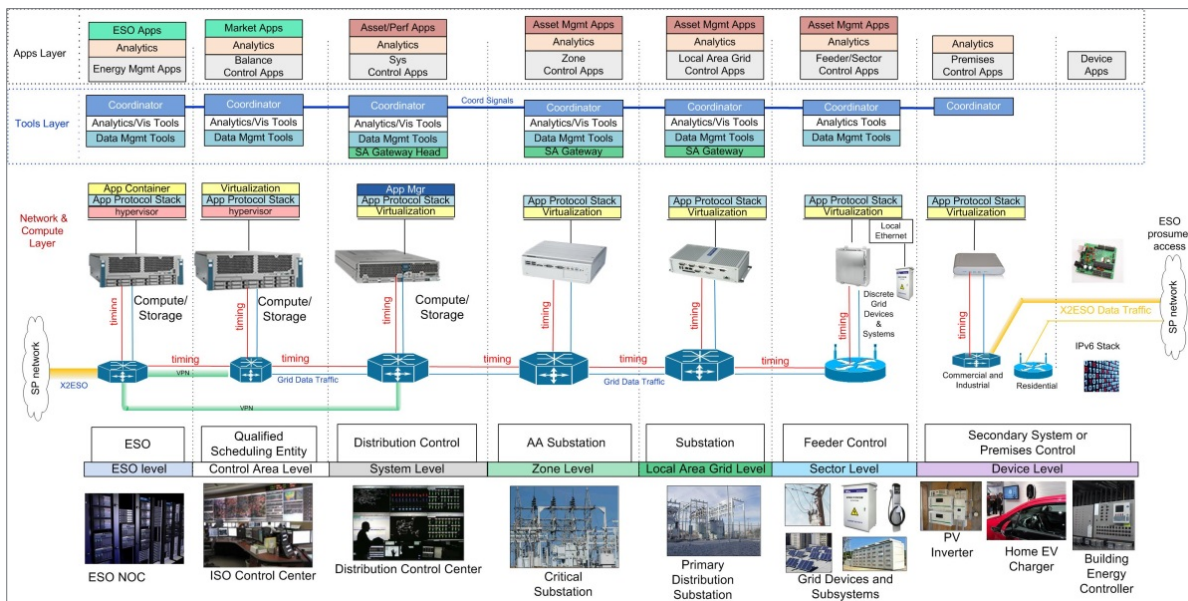

Figure 8. Distributed Computing for Infrastructure

The presence of computing capability in the substations is the primary reason for aggregating feeder communications traffic to the substations. In addition to minimizing latency (if the data paths are direct) this configuration enables substations to operate autonomously in demanding real time situations and in the event of a loss of communication to a control or operations center. The latter is an argument for resilience in face of natural disasters or attack.

A variety of tools are available for implementation of the DCI computing environments: embedded code, agents, dockers, virtualization, etc. It is essential, however, that the communication network and the computational elements have a common means for remote management. The computational elements

¹⁸ <http://xmpp.org/extensions/xep-0322.html>

¹⁹ <https://tools.ietf.org/html/rfc6407>

²⁰ Adapted with permission from Cisco Systems.

have requirements similar to FCAPS²¹ for communications and being decentralized, must be deployed, provisioned, operated, and managed in a zero touch manner.

Note that the paradigms of Sensor Network Infrastructure, Laminar Networks, and Distributed Computation for Infrastructure are mutually compatible. This is because SNI defines an infrastructure layer with flexible access, DCI adds to that infrastructure, and Laminar Networks supply logical data flow models. Laminar Networks can be implemented using SNI and DCI, with DCI elements hosting Laminar Coordination nodes for example.

2.8 Networking Outside the Utility Fence

This section employs Graphical String Notation to illustrate various communication structure options. Graphical String Notation is described in Appendix A.

As penetration of DER continues, there will be an increasing number of devices that are owned by prosumers, and are controlled by those prosumers or by aggregators, or merchant DER operators. In addition, any commercial buildings are managed for energy purposes through remote building energy management operations centers that may be owned by the building owner or may be third parties. To coordinate the operations of these assets with the grid means using communications that connect to the DER assets outside the utility fence or to any of the multiple classes of third parties that have direct control of the DER assets. In the case of the third parties, the control centers may not be located in the service area of the distribution utility that is electrically connected to the DER asset. In fact, the third party operations centers may not even be in the same state as the DER assets they manage. The following discussion provides a stepwise refinement view of such networking. This is important to understand because it is generally not practical to expect that DER assets will communicate directly through utility communication networks.

When the DER assets are being used solely at the bulk system level, there is some locational value effect, but the effect is not very granular and the communications can be between the DER assets or their third party managers and the TO or BAA, which is relatively simple to accomplish and already done at many ISOs as Figure 9 illustrates. This usage does not require detailed knowledge of DER electric connectivity at the feeder level and does not require knowledge of feeder level electrical state.

However, as distribution utilities begin to use DER for sophisticated purposes, which will become increasingly valuable and necessary as the volume of DER increases, much finer granularity (down to the feeder section level) will eventually be needed. When DER is being used to mitigate distribution level congestion, knowledge of DER electrical connectivity and feeder electrical state becomes crucial and the distributed approach to coordination of DER assets becomes more complex than in the bulk system case.

One approach would be to duplicate the bulk system communication arrangement at the distribution level and Figure 9 also illustrates this case.

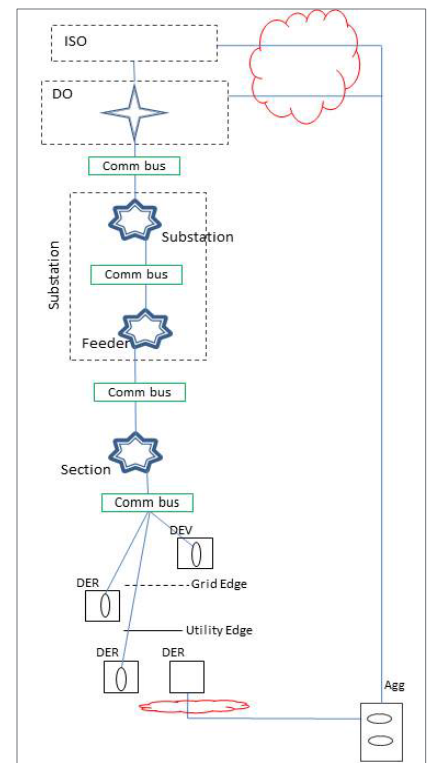

Figure 9. Aggregations into DO and ISO

²¹ https://thwack.solarwinds.com/community/solarwinds-community/geek-speak_tht/blog/2013/03/14/network-management-functions-the-fcaps-model

If the DER assets are used by both the ISO and the DO (perhaps via a DSO mechanism) as is being proposed in some jurisdictions, then an issue of potential dual control of a single asset arises and there is a need to resolve control via a coordination mechanism. Some prices-to-devices efforts along this line have resulted in prices at the edge devices being over-written by separate control processes, so this is a realistic problem. The model of Figure 9, presumes centralized dispatch of DER at the distribution level and knowledge of distribution electric connectivity and grid state is handled at the distribution operations center. Consequently, no coordination mechanisms are actually needed at the substation, feeder, or feeder section level, since the DO will perform the DER dispatch directly.

If the distribution utility wishes to use Laminar Networks to implement distributed Transactive Energy solutions for DER management in order to mitigate finely granular effects such as congestion induced voltage, protection, and thermal violations then the communication architecture is more complicated. Several options are possible:

- Direct connection from feeder section coordinator to DER element
- Direct connection from feeder section coordination to aggregator
- Indirect connection from feeder section coordinator to aggregator via the DO

Figure 10 below illustrates these options. The middle and right hand diagrams in Figure 10 show two additional important options: in the middle diagram the aggregator hosts *coordination nodes*²²—one for each coordination zone in which it has assets. In the right hand diagram, the aggregator hosts *terminal nodes*²³ - one for each DER asset it manages. This difference is significant because the latter arrangement means that the aggregator can continue to use the interfaces it already has with DER assets, whereas in the middle diagram, the interfaces between DER asset and aggregator must change to accommodate laminar coordination data flow which present interfaces do not handle.

²² Coordinator nodes perform the coordination function for layered decomposition, and may provide other services for coordination domains.

²³ Terminal nodes are coordinator nodes at edge DER devices; they only need to provide the processing for the final stage of the layered decomposition coordination process.

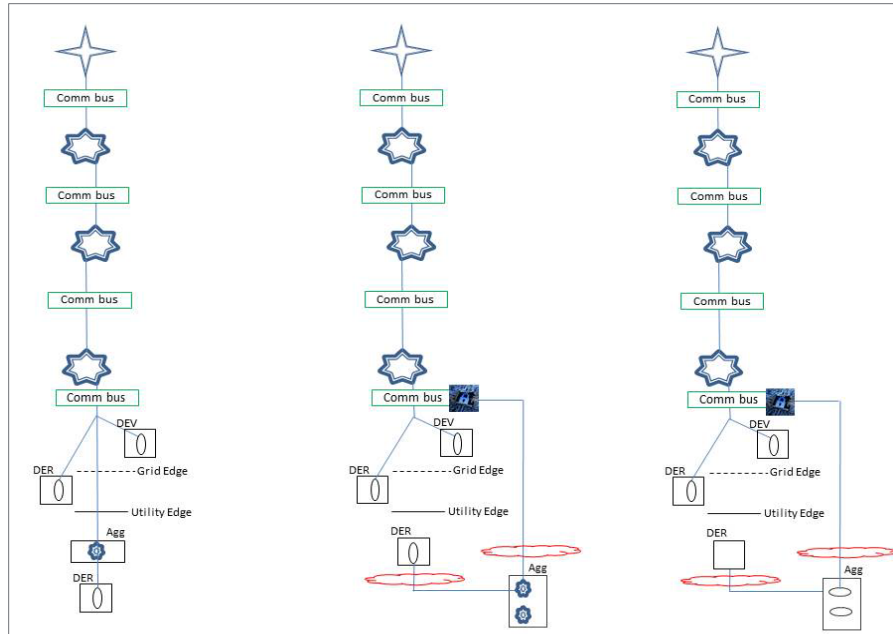

Figure 10. Basic Laminar Coordination Options

When the distribution utility has a network that can reach all the DER assets, then completion of the Laminar Network is relatively easy. The lack of such a network or the presence of aggregators and third party ESOs complicates this completion. However, the ability of third parties to host either laminar coordinator nodes or laminar terminal nodes can resolve the issue. This capability points to a new value that third parties can provide to utilities in a distributed Transactive Energy model: hosting the laminar nodes that complete the Laminar Coordination Framework and eliminating the need for the utility to handle communication/coordination interfaces directly to the DER devices managed by those third parties.

The diagrams of Figure 10 still have issues. In the middle and right hand illustrations, each feeder section coordinator node or associated communication bus must have a connection to the external network (likely the internet) that provides communication connectivity with the aggregators. If this involves putting extra interfaces at the coordination nodes that connect to an external network, in addition to the existing connections to the utility network, then not only would this be expensive, it also represents a cybersecurity problem, with what amounts to deep internet penetration into the distribution infrastructure, resulting in a potentially large number of new points to be secured. It is not necessary or desirable to do that. Instead it would be much better to keep the interface exposure small and this leads to the models of Figure 11. In these models, the external third parties interface through the distribution operator, but communication is provided to the appropriate feeder section coordinator communication bus. This comes by way of a bridge router or other mechanism where a centrally managed set of security measures can be applied at a single point of interface at the DO, rather than spread throughout the distribution grid, this limiting both the interface cost and the cybersecurity exposure.

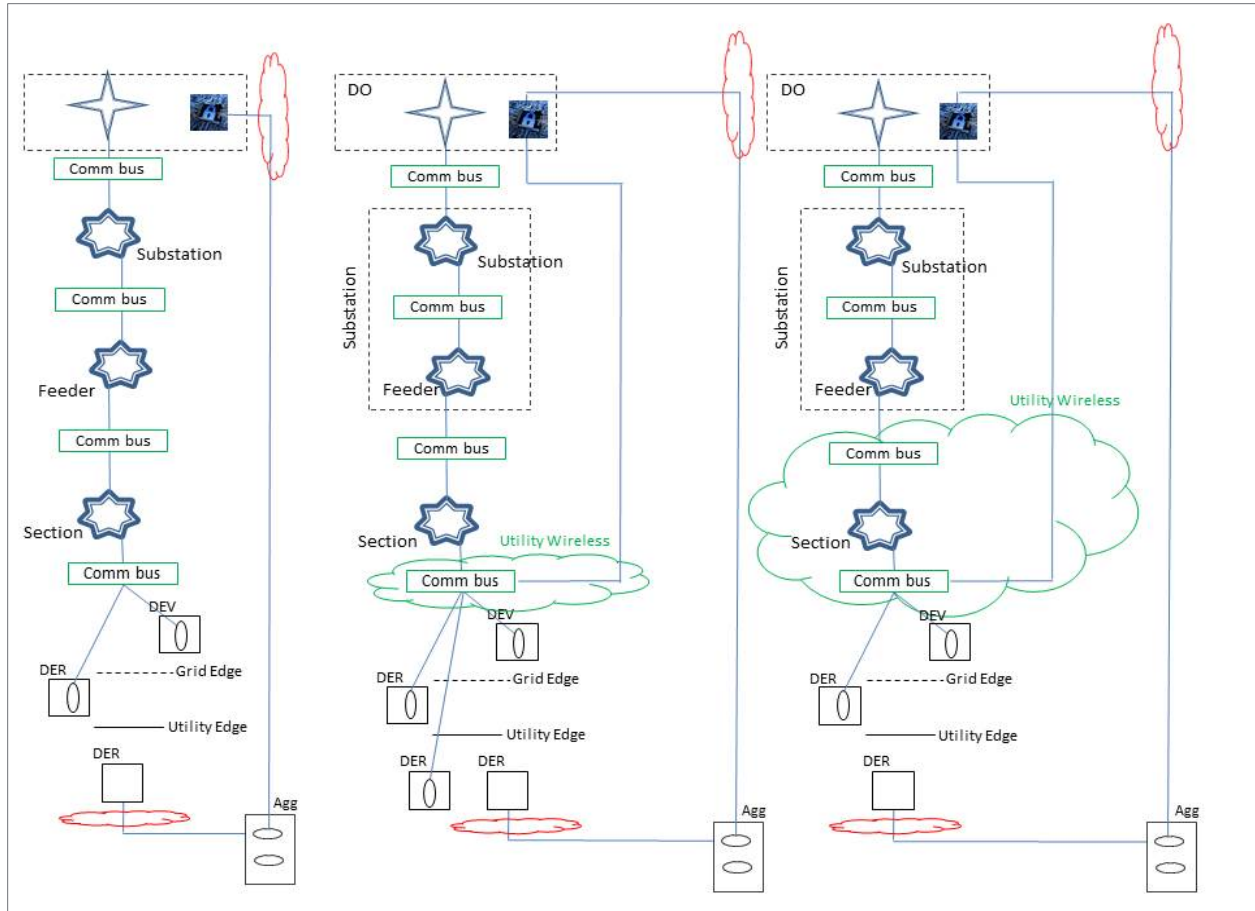

Figure 11. Third Party Connectivity to Coordination Nodes through the DO

Depending on the nature of the distribution communication network, the data flows for the externally connected DERs may be via the same chain as the rest of the inter-layer aggregation, or may more or less direct to the specific coordination domain communication bus. The specific solution depends on the nature of the underlying physical network, which of course may take any of several configurations based on the type of physical media involved.

The cyber security issues introduced by the presence of external data connectivity are not essentially any worse in these configurations than in other approaches to DER coordination. In fact, using aggregators is potentially helpful in that it reduces the number of interfaces the utility must handle and secure, and appropriate terms can be put into Grid Codes (interconnection agreements) to specify cyber security requirements. This approach is also an illustration of the concept of *structural security*, wherein the network structure itself is chosen to aid in the securing of the information flows.

2.9 Control System/Network Interaction

Due to the geographic dispersion of electric grid assets (and other kinds of physical infrastructure), control systems must employ networking in various forms: wide area networks at the bulk system level and for primary distribution substations, intra-substation networks, field area networks for distribution feeders, and neighborhood area networks for edge devices. Closed loop control has been limited to rather slow dynamics and power system control design has tended to treat the communication networks as if they were ideal in nature. With the deployment of PMUs at the transmission level and the emergence of

applications for fast closed loop control (e.g. for damping of inter-area oscillations), the dynamic behavior of the communication network can have a significant impact on behavior of the closed loop control. To mitigate performance issues that can arise from this interaction, an emerging technology called Software Defined Networking²⁴ can facilitate a new kind of control system-network structure and interaction. Figure 12 illustrates the structure of a combined control/communication network using remote PMU sensing with a Universal Power Flow Controller to manage bulk system stability. An SDN interface between the controller and the communication network provides the mechanism to converge the control and communication networks into a single platform. In this manner, the control can adjust network performance, or be informed of network conditions so as to adjust grid control parameters.²⁵ It is reasonable to expect that such structures will eventually become useful at the distribution level as DER causes distribution grid complexity to increase.

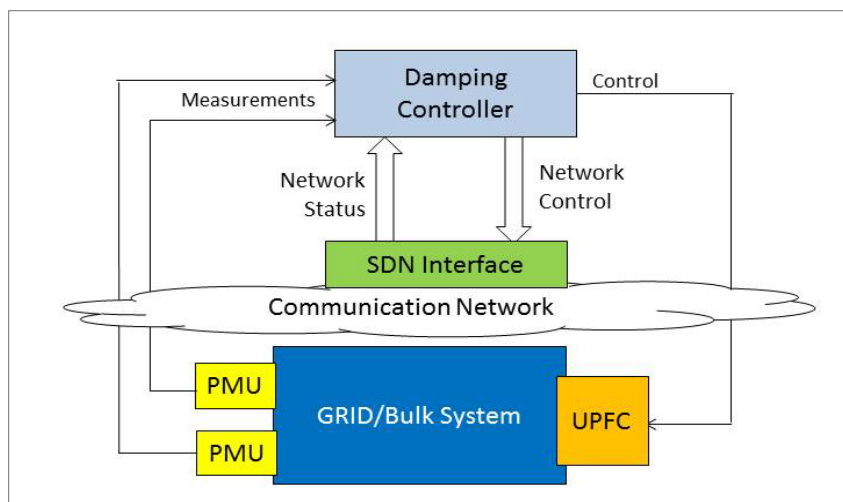

Figure 12. Control System/Communication Network Convergence via SDN

SDN is a mechanism that can enable grid controls system/communication network convergence, meaning that a new platform with seamless control/communication architecture can be implemented.

3.0 Network Convergence Issues

In general, we find three types of relationships between heterogeneous networks: dependence, integration, and convergence. A common example of dependence has been the dependence of some electric generation upon delivery of natural gas for fuel. Integration involves the interconnection of various systems and components to provide a specified functionality. Considerable attention has been paid to integration of rooftop solar and distribution grids via controllable inverters. Network convergence is a more powerful and large scale phenomenon however.

²⁴ <https://www.opennetworking.org/sdn-resources/sdn-definition>

²⁵ JD Taft, "Grid Architecture 2," pp. 3.49-3.52, <http://gridarchitecture.pnnl.gov/media/white-papers/GridArchitecture2final.pdf>

Convergence is the transformation of two or more networks or systems to share resources and interact synergistically via a common and seamless architecture, thus enabling new value streams.²⁶ Figure 13 below illustrates a number of actual and expected network convergences involving the electric grids in the US.

Network convergence come about through various market and regulatory forces and is important because of the issue of converged network platform formation. To appreciate this, it is necessary to understand where grid-related network convergence occurs.

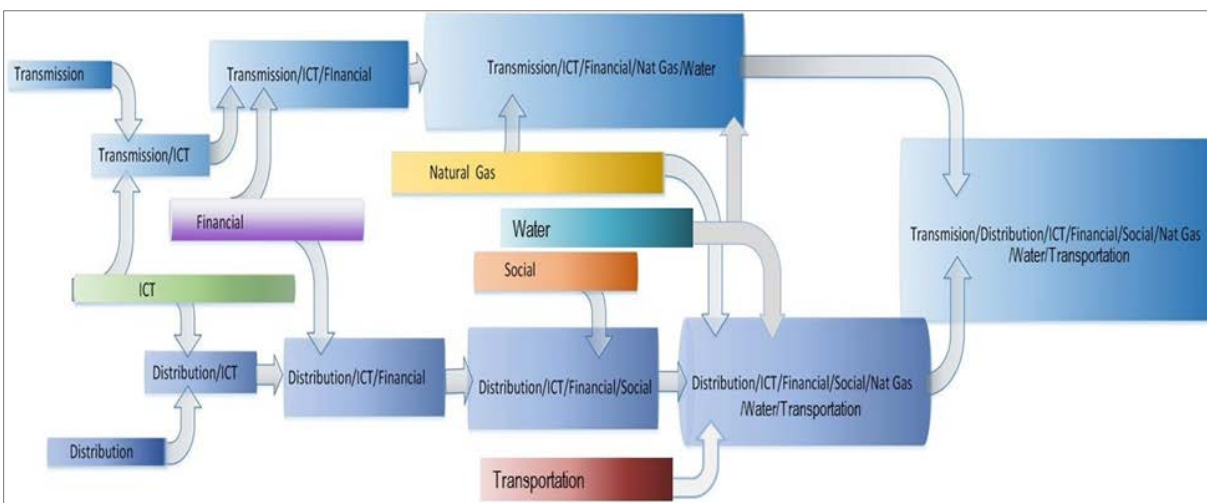

Figure 13. Network Convergences

Convergence of grid-related networks occurs in the *market-control nexus*, and the emergent platforms involve *control systems, market mechanisms, and communication networks*. Given this, the design of electric distribution communication networks should recognize the potentially expanding role of communications in the operational sides of more than just electric distribution, especially in the smart cities context. The implications of this point to the need for high performance communications networks, comprehensive network level cyber security architecture, and deep understanding of the infrastructures or other networks being converged.

4.0 Conclusions

Emerging trends for electric distribution and other distribution infrastructures point to the need to move from low performance hub-and-spoke networks and multiple non-converged communications systems to new network models. These trends include increasingly fast distribution dynamics caused by the insertion of variable energy resources such as rooftop solar into the distribution grid, the participation of buildings as sources of services to the grid, the potential impact of storage in the grid, and the introduction of market mechanisms into grid operations at the distribution level. Additionally, some distribution utilities are considering modifying business models in response to potential grid defection by changing from being one-way energy delivery channels to being open-access networks upon which many parties can exchange electric energy and related services. In these models, the distribution operator becomes a

²⁶ P De Martini and JD Taft, “Value Creation Through Integrated Networks and Convergence,” <http://gridarchitecture.pnnl.gov/media/advanced/Electric%20Networks%20%20Convergence%20final%20version%20%20Mar%2015%202015.pdf>

network manager and the flows of information and energy are more nearly meshed than bidirectional between the utility and end users. Finally, the discussions about redefining the roles and responsibilities of distribution operators are underway in many states and have the potential to change the basic relationships between distribution and bulk energy systems, as well as between distribution operators and users of the distribution grids.

In this document, several new communication network paradigms are introduced:

- System Control Networks
- Substation Aggregation
- Distribution Fiber to Premises and Private LTE
- Publish/Subscribe Networks
- Sensor Network Infrastructure
- Laminar Networks
- Distributed Computing for Infrastructure

Architectures and designs that employ layered models, information in motion concepts, and converged computing, communication, and structural cyber-security concepts offer the means to address evolving distribution system communication needs but are departures from traditional approaches. The paradigms listed above can be employed separately or in groups to develop network architectures and designs for modernized distribution systems. The Laminar Networks paradigm is intended for distributed coordination of grid circuits and attached DER assets in general, but also constitutes a framework for Transactive Energy systems in particular.

The adoption of these paradigms will enable distribution utilities to develop their next generation of communication networks in ways that support grid modernization and incorporate a degree of future-proofing so as to help manage the risks of stranded investments or unrealized value.

Appendix A
Graphical String Notation

Appendix A

Graphical String Notation

In order to represent a variety of coordination communication structures it is helpful to abstract the essential structure from the larger view of a grid. Figure A.1 below is a simple illustration of a utility structure with a Laminar Coordination Framework. Framework elements are represented in one of three forms: top level coordination node (4 point star), general coordination node (7 point star), or terminal mode (oval). Terminal nodes are coordination nodes at grid edge endpoint devices.

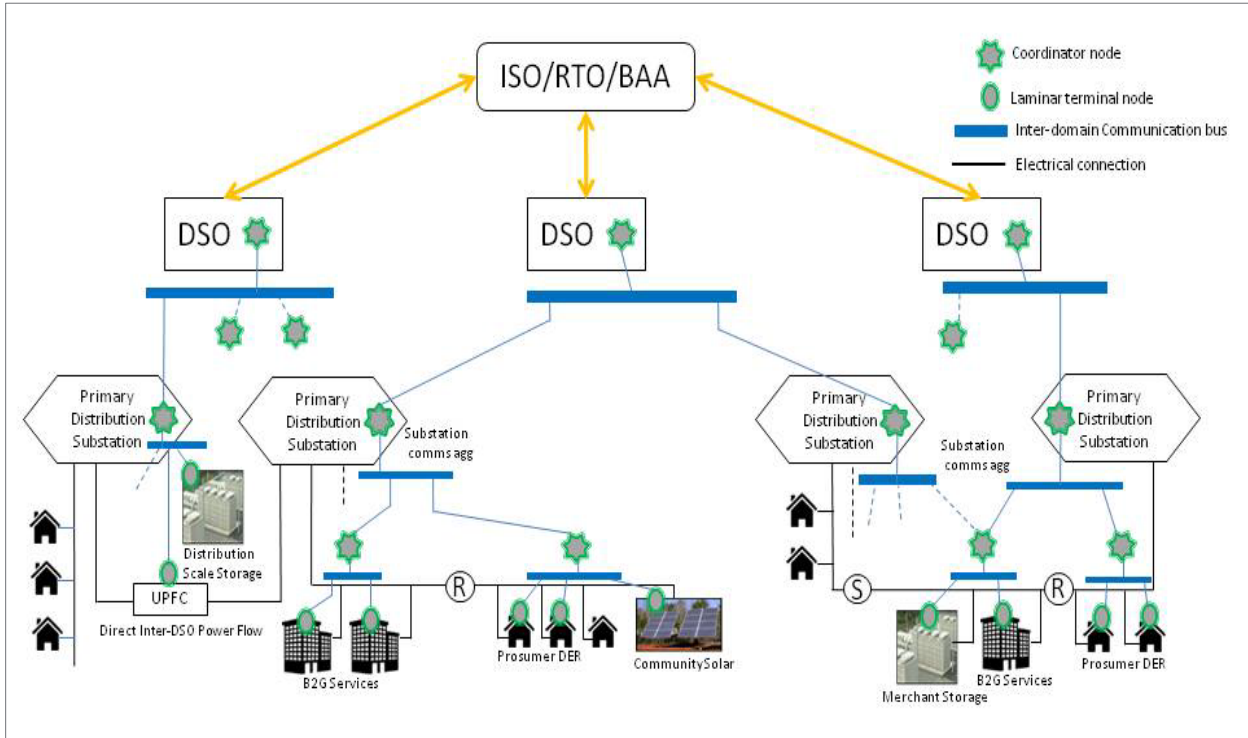

Figure A.1. Utility Diagram with Laminar Coordination

In Figure A.2, the essential coordination framework is depicted in tree structure form. The tree structure diagram is then converted to the graphical string diagram on the right of Figure A.2 by extracting the central core outlined in red. Laminar Coordination Framework elements are represented in one of three forms: top level coordination node (4 point star), general coordination node (7 point star), or terminal mode (oval). Connecting lines are lines of coordination and therefore communication. The boxes labeled “Comm Bus” indicate communication buses for inter-tier and intra-tier peer-to-peer communication (refer to Figure 6 in the main text above). The grid edge and utility boundary are represented by a dashed line and a solid line respectively. Edge devices that are inside the solid line but outside the dashed line are utility-owned distribution-connected DER. Distributed-connected grid components (capacitors, switches, reclosers, grid sensors, etc.) are not considered edge devices, but as grid devices and so are inside the grid edge line.

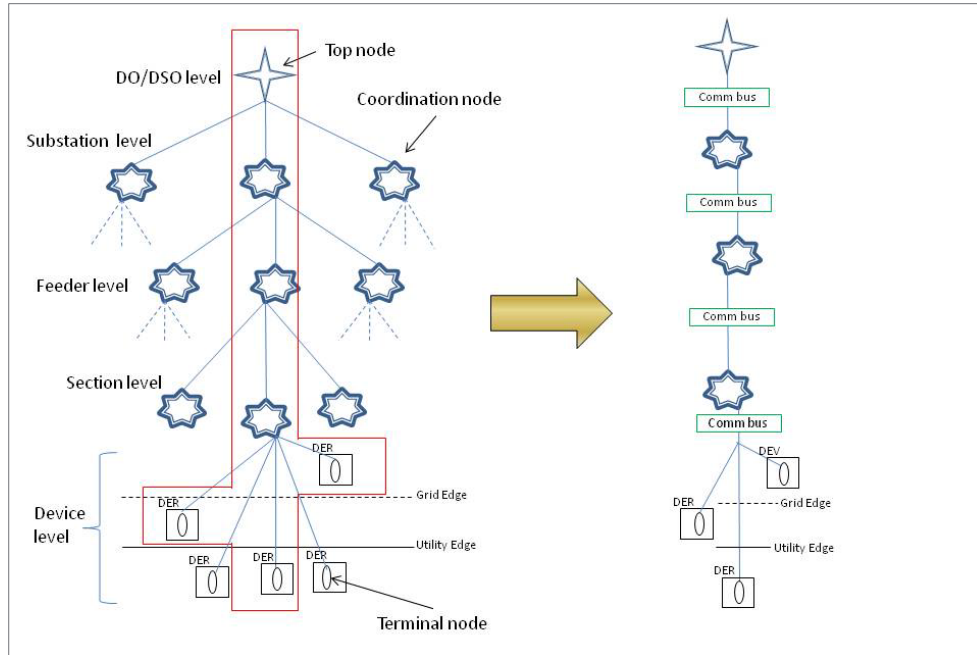

Figure A.2. Extraction of a Graphic String Model

This particular diagram pair in Figure A.2 spans the grid from DO/DSO to endpoint devices and includes devices outside the utility. In general, graphical string diagrams can reach from the TO/BAA level or even the regional reliability coordinator level through to prosumer endpoints and may also include non-utility organizations such as DR aggregators, ESOs, and merchant DER operators. Internet communications may be represented as red clouds, and utility wireless networks may be represented as green clouds. Figure A.3 shows an example with both internet and a utility wireless field area network.

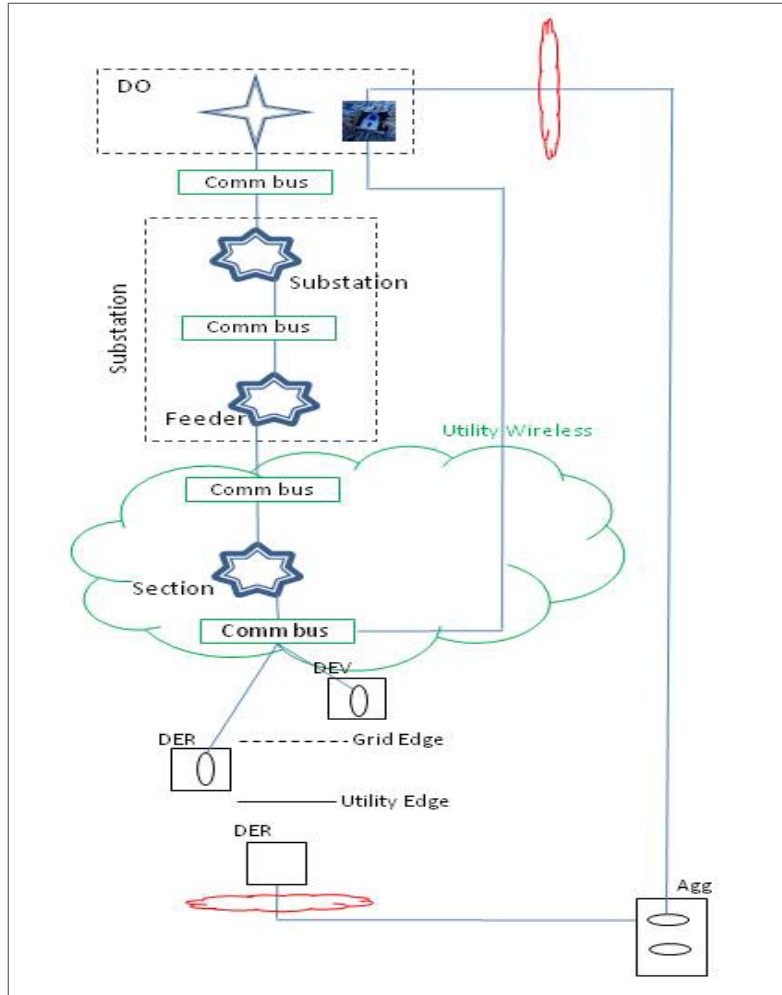

Figure A.3. Example with Internet and Utility Wireless Network



Pacific Northwest
NATIONAL LABORATORY

*Proudly Operated by **Battelle** Since 1965*

902 Battelle Boulevard
P.O. Box 999
Richland, WA 99352
1-888-375-PNNL (7665)

U.S. DEPARTMENT OF
ENERGY

www.pnnl.gov